



## 500V N-Channel MOSFET

## FQD5N50

### DESCRIPTION

These N-Channel enhancement mode power field effect transistors are produced using Fairchild's proprietary, planar stripe, DMOS technology.

This advanced technology has been especially tailored to minimize on-state resistance, provide superior switching performance, and withstand high energy pulse in the avalanche and commutation mode. These devices are well suited for high efficiency switch mode power supply.

### ABSOLUTE MAXIMUM RATINGS ( Ta = 25 °C)

Parameter	Symbol	Value	Unit
Drain-Source Voltage	$V_{DSS}$	500	V
Drain Current - Continuous	$I_D$	3.5	A
Drain Current - Pulsed	$I_{DM}$	14	A
Gate-Source Voltage	$V_{GSS}$	$\pm 30$	V
Power Dissipation	$P_D$	50	W
Max. Operating Junction Temperature	$T_j$	150	°C
Storage Temperature	$T_{stg}$	-55~150	°C

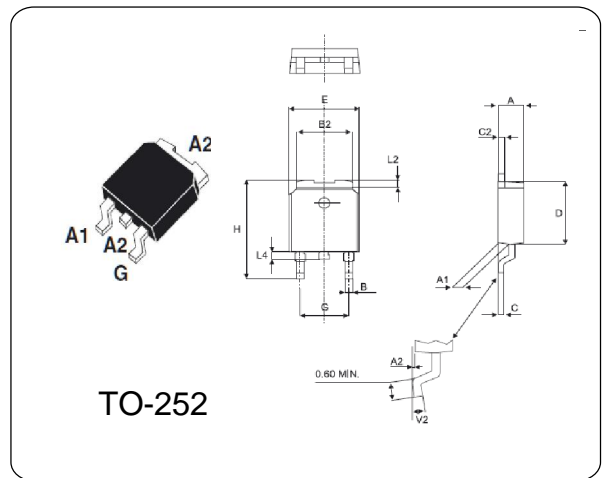

### ELECTRICAL CHARACTERISTICS ( Ta = 25 °C)

Parameter	Symbol	Test Conditions	Min.	Typ.	Max.	Unit
Drain-Source Breakdown Voltage	$BV_{DSS}$	$V_{GS} = 0V, I_D = 250 \mu A$	500	—	—	V
Zero Gate Voltage Drain Current	$I_{DSS}$	$V_{DS} = 500V, V_{GS} = 0V$	—	—	1.0	$\mu A$
Gate-Body Leakage Current, Forward	$I_{GSSF}$	$V_{GS} = 30V, V_{DS} = 0V$	—	—	100	nA
Gate-Body Leakage Current, Reverse	$I_{GSSR}$	$V_{GS} = -30V, V_{DS} = 0V$	—	—	-100	nA
Gate Threshold Voltage	$V_{GS(th)}$	$V_{DS} = V_{GS}, I_D = 250 \mu A$	3.0	—	5.0	V
Static Drain-Source On-Resistance	$R_{DS(on)}$	$V_{GS} = 10V, I_D = 1.75A$	—	—	1.8	W
Drain-Source Diode Forward Voltage	$V_{SD}$	$V_{GS} = 0V, I_S = 3.5A$	—	—	1.4	V

Typical Characteristics

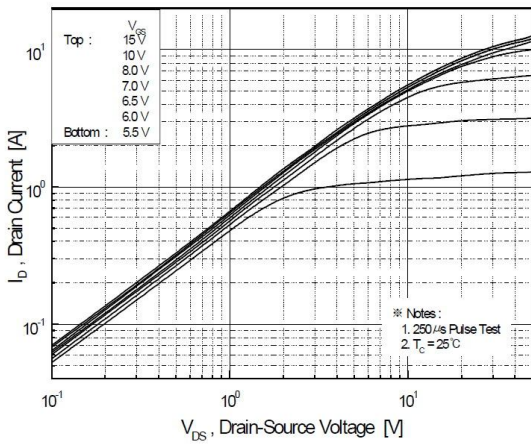

Figure 1. On-Region Characteristics

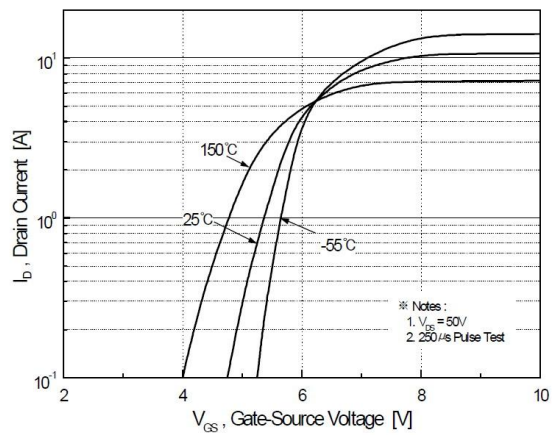

Figure 2. Transfer Characteristics

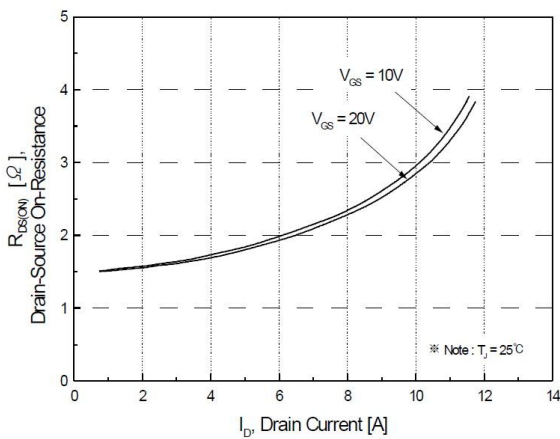

Figure 3. On-Resistance Variation vs. Drain Current and Gate Voltage

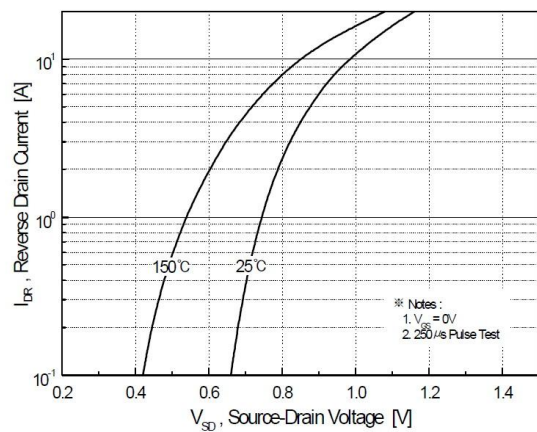

Figure 4. Body Diode Forward Voltage Variation vs. Source Current and Temperature

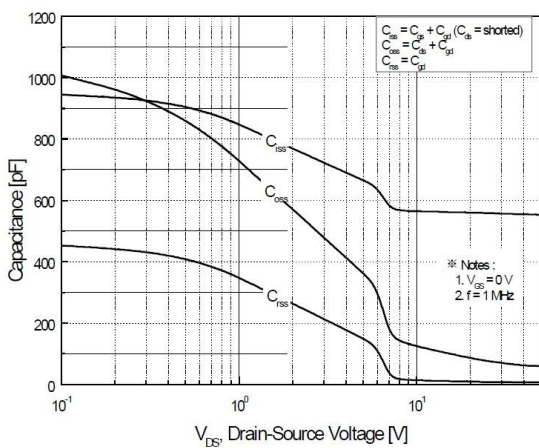

Figure 5. Capacitance Characteristics

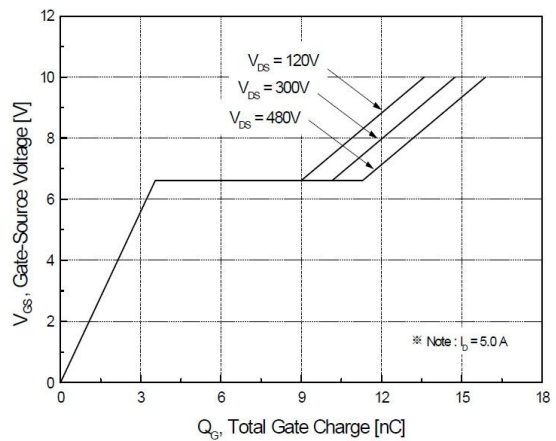

Figure 6. Gate Charge Characteristics