



6A TRIACS

T610-600B-TR

GENERAL DESCRIPTION

Available either in through-hole or surface-mount packages, the T610 - 600B triac series is suitable for general purpose AC switching. They can be used as an ON/OFF function in applications such as static relays, heating regulation, induction motor starting circuits... or for phase control operation in light dimmers, motor speed controllers, ...

The snubberless versions (T6 Series) are specially recommended for use on inductive loads, thanks to their high commutation performances. By using an internal ceramic pad,

ABSOLUTE MAXIMUM RATINGS (Ta = 25 °C)

PARAMETER	Symbol	Value	Unit
Repetitive peak off-state voltages	V_{DRM}	600	V
peak off-state reverse voltages	V_{RRM}	600	V
RMS on-state current	I_T	6.0	A
Non-repetitive peak on-state current	I_{TSM}	63	A
Max. Operating Junction Temperature	T_j	110	°C
Storage Temperature	T_{stg}	-45~150	°C

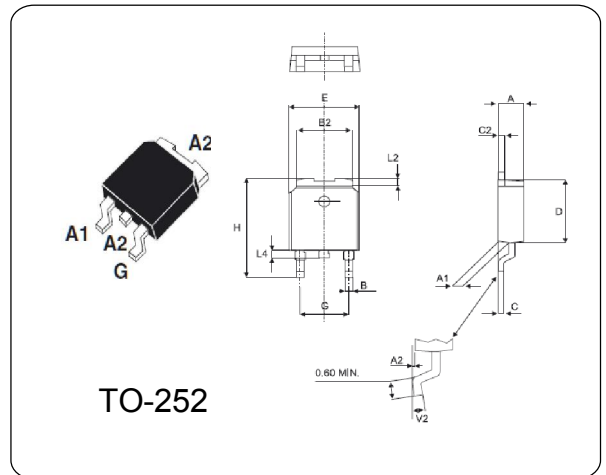

ELECTRICAL CHARACTERISTICS (Ta = 25 °C)

PARAMETER	Symbol	Test Conditions	Min.	Max	Unit
Repetitive peak off-state voltages	V_{DRM}	$I_D=0.1mA$	600	—	V
Repetitive peak off-state current	I_{DRM}	$V_{DRM}=520V$	—	10	uA
On-state voltage	V_{TM}	$I_T=5.5A$ $t_p=380\mu s$	—	1.55	V
Holding current	I_H	$I_T=0.5A, I_{GT}=20mA$	—	25	mA
Gate trigger Current	T2+G+	$V_{AK}=12V, R_L=30\Omega$	—	10	mA
	T2+G-		—	10	
	T2-G-		—	10	
	T2-G+		—	25	
Gate trigger Voltage	T2+G+	$V_D=12V, R_L=30\Omega$	—	1.3	V
	T2+G-		—	1.3	
	T2-G-		—	1.3	
	T2-G+		—	1.3	