

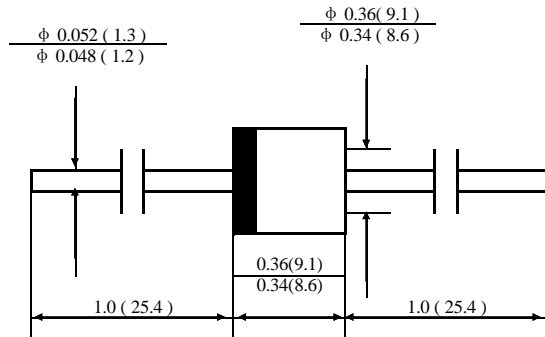

### 6.0AMP FAST RECOVERY RECTIFIERS

VOLTAGE RANGE: 50 to 1000 VOLTS

R-6



inch ( mm )

### FEATURES

- . Low cost
- . Diffused junction
- . Low Leakage
- . Low forward voltage drop
- . High current capability
- . Easily cleaned with Freon. Alcohol. Isopropanol and similar solvents
- . The plastic material carries U/L recognition 94V-0

### MECHANICAL DATA

- . Case: JEDEC R-6. molded plastic
- . Terminals: Axial leads. Solderable per MIL - STD - 202. Method 208
- . Polarity: Color band denotes cathode
- . Weight: 0.074 ounce. 2.1 grams
- . Mounting position: Any

### MAXIMUM RATINGS AND ELECTRICAL CHARACTERISTICS

Ratings at 25 °C ambient temperature unless otherwise specified.

Single phase half wave 60HZ. resistive or inductive load. For capacitive load current derate by 20%

	SYMBOL	FR601	FR602	FR603	FR604	FR605	FR606	FR607	UNITS
Maximum Recurrent Peak Reverse Voltage	$V_{RRM}$	50	100	200	400	600	800	1000	V
Maximum RMS Voltage	$V_{RMS}$	35	70	140	280	420	560	700	V
Maximum DC Blocking Voltage	$V_{DC}$	50	100	200	400	600	800	1000	V
Maximum Average Forward Rectified Current 9.5mm Lead Length. $T_A = 55^\circ C$	$I_{(AV)}$	6.0							A
Peak Forward Surge Current 8.3ms Single half-sine-wave superimposed on rated load	$I_{FSM}$	200							A
Maximum Forward Voltage at 6.0A DC	$V_F$	1.3							V
Maximum Reverse Current $T_A = 25^\circ C$ at Rated DC Blocking Voltage $T_A = 100^\circ C$	$I_R$	10.0							$\mu A$
		200.0							
Maximum Reverse Recovery Time (Note 1)	$t_{rr}$	150			250	500		ns	
Typical Junction Capacitance (Note 2)	$C_j$	55							pF
Operating Junction Temperature Range	$T_j$	- 55 to 125							$^\circ C$
Storage Temperature Range	$T_{STG}$	- 55 to 150							$^\circ C$

NOTE: 1.Measured with  $I_F=0.5A, I_R=1A, I_{rr}=0.25A$ .

2.Measured at 1.0MHz and applied reverse voltage of 4.0V DC.

3.Thermal Resistance Junction to Ambient.



# TIGER ELECTRONIC CO.,LTD

## FR601 THRU FR607

FIG. 1 -- TYPICAL FORWARD CHARACTERISTIC

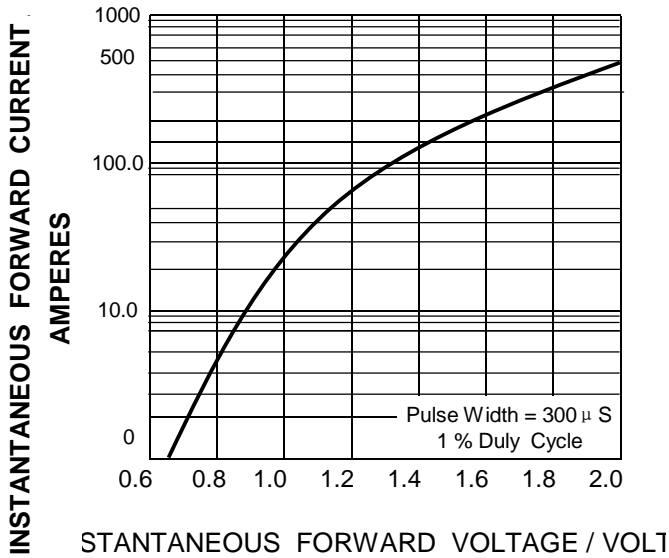

FIG. 2 -- TYPICAL JUNCTION CAPACITANCE

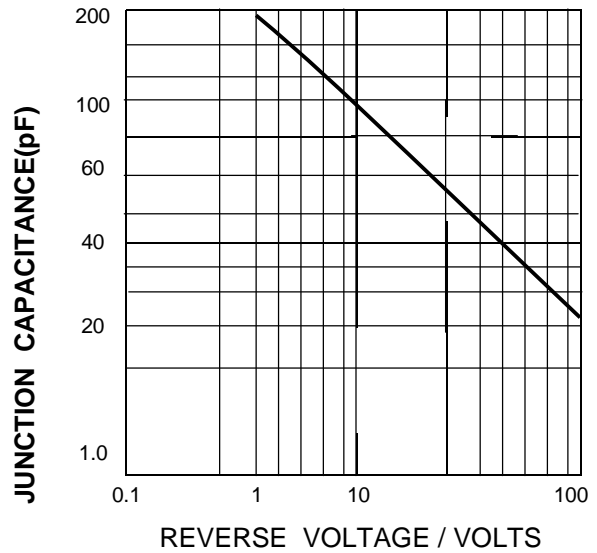

FIG. 3 -- FORWARD CURRENT DERATING CURVE

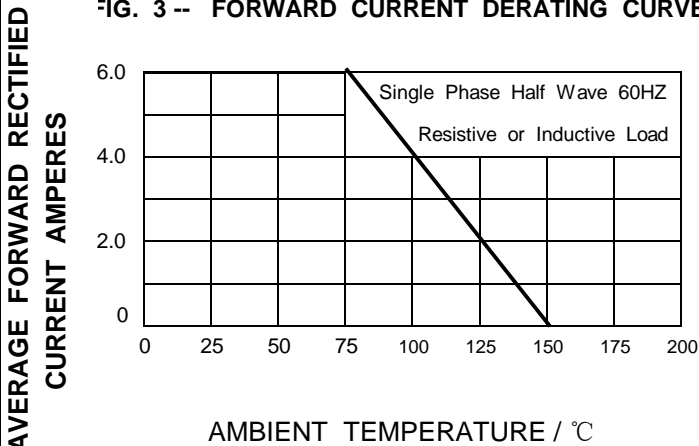

FIG. 4 -- PEAK FORWARD SURGE CURRENT

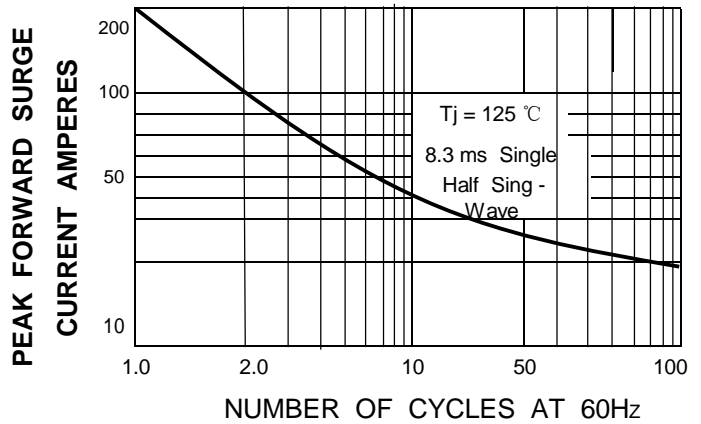
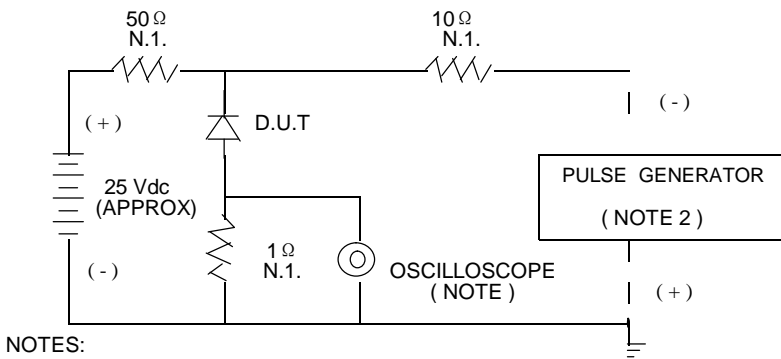
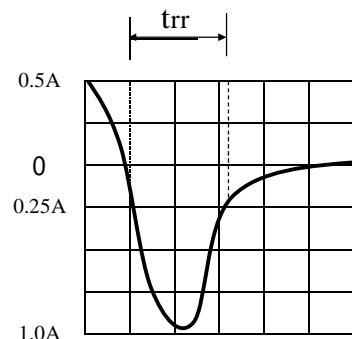

FIG. 5 -- TEST CIRCUIT DIAGRAM AND REVERSE RECOVERY TIME CHARACTERISTIC



NOTES:

1. RISE TIME = 7n SEC MAX. INPUT IMPEDANCE = 1 MEGOHM
2. RISE TIME = 10n SEC MAX. SOURCE IMPEDANCE = 50 OHM



SET TIME BASE FOR 15 ns / cm