

Low-Noise Dual Operational Amplifier LM833N/D/S

DESCRIPTION

The LM833 is a high performance, low noise dual operational amplifier. This amplifier features popular pin-out, superior noise performance, and superior total harmonic distortion. This amplifier also features guaranteed noise performance with substantially higher gain-bandwidth product and slew rate, which far exceeds that of the 4558 type amplifier. The specially designed low noise input transistors allow the LM833 to be used in very low noise signal processing applications such as audio preamplifiers and servo error amplifier.

FEATURES

- Operating Voltage: $\pm 4V \sim \pm 18V$
- Low Total Harmonic Distortion (0.001%typ.)
- Low Noise Voltage
- High Slew Rate ($6V/\mu s$ typ.)
- Unity Gain Bandwidth ($27MHz@f=10kHz$)
- Bipolar Technology

Outline Drawing

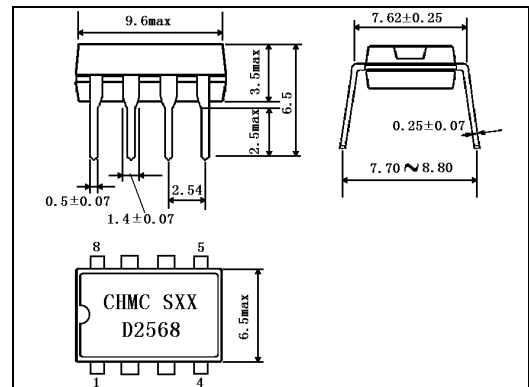

DIP8

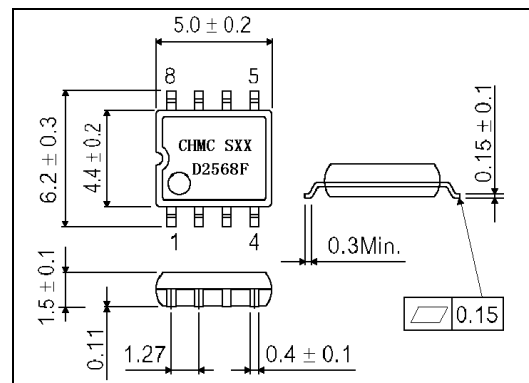

SOP8

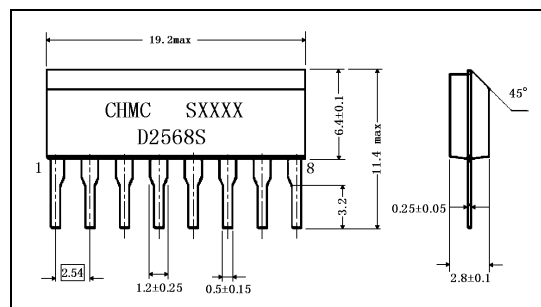

SIP8

PIN CONNECTION

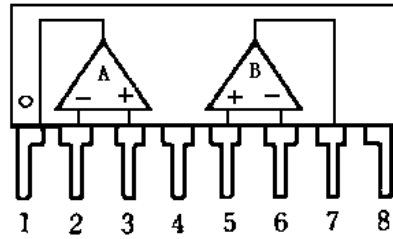
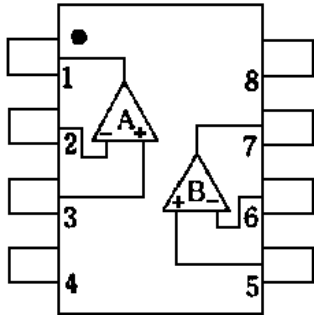

PIN FUNCTION

- 1 A OUTPUT
- 2 A-INPUT
- 3 A+INPUT
- 4 V⁻
- 5 B+INPUT
- 6 B-INPUT
- 7 B OUTPUT
- 8 V⁺

BLOCK DIAGRAM

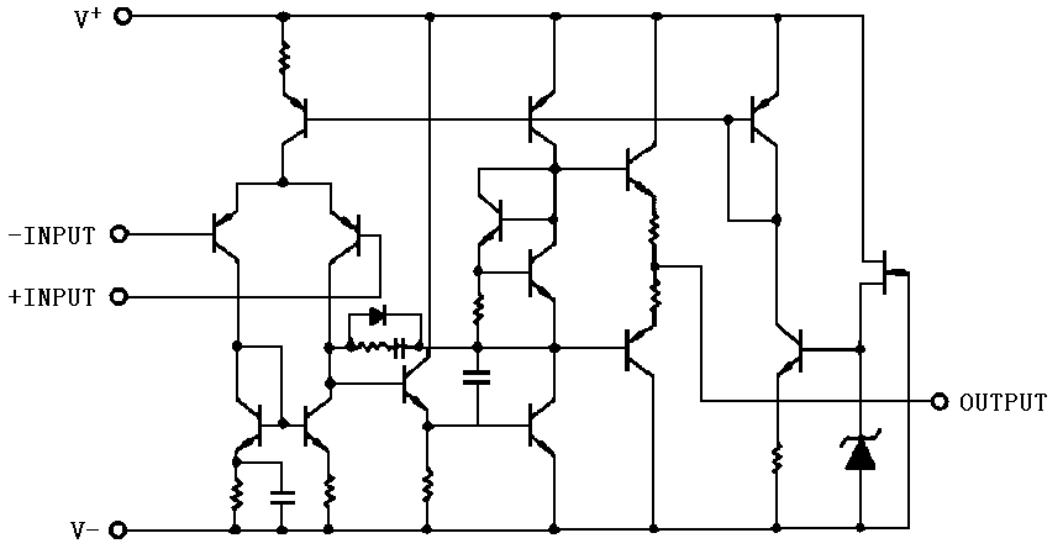

ABSOLUTE MAXIMUM RATINGS (Ta=25°C)

Characteristic		Symbol	Value	Unit
Power Supply voltage		V ⁺ /V ⁻	±18	V
Input Voltage		V _{IC}	±15*	V
Differential Input Voltage		V _{ID}	±30	V
Power Dissipation	DIP8	Pd	500	mW
	SOP8		300	
	SIP8		800	
Operating temperature		T _{opr}	-20~+75	°C
Storage temperature		T _{stg}	-40~+125	°C

* For supply voltage less than ±15V, the absolute maximum input voltage is equal to the supply voltage.

ELECTRICAL CHARACTERISTICS

(Unless otherwise specified: $V^+/V^- = \pm 15V$, $T_a = 25^\circ C$)

Characteristics	Symbol	Test conditions	Min	Typ	Max	Unit
Input Offset Voltage	V_{IO}	$R_s \leq 10k\Omega$		0.3	3	mV
Input Offset Current	I_{IO}			5	200	nA
Input Bias Current	I_B			150	1000	nA
Input Resistance*	R_{IN}		50	300		k Ω
Large Signal Voltage Gain	A_V	$R_L \geq 2k\Omega, V_o = \pm 10V$	90	120		dB
Maximum Output Voltage Swing	V_{OM}	$R_L \geq 2k\Omega$	± 12	± 13.5		V
Input Common Mode Voltage Range	V_{ICM}		± 12	± 13.5		V
Common Mode Rejection Ratio	CMR	$R_s \leq 10k\Omega$	80	110		dB
Supply Voltage Rejection Ratio	SVR	$R_s \leq 10k\Omega$	80	120		dB
Slew Rate	SR	$R_L \leq 2k\Omega$		6		V/ μ s
Gain Bandwidth Product 1	GB1	$f = 10kHz$		27		MHz
Gain Bandwidth Product 2	GB2	$f = 100kHz$		19		MHz
Unity Gain Bandwidth	f_T	$A_V = 1$		5.5		MHz
Total Harmonic Distortion	THD	$A_V = 20dB, V_o = 5V, R_L = 2k\Omega, f = 1kHz$		0.001		%
Equivalent Input Noise Voltage 1	V_{NI1}	$R_s = 300\Omega$		0.44	0.56	μ V
Operating Current	I_{cc}			5.0	8.0	mA

* Oscillation might be caused when capacitor type load were connected. It is recommendable to insert series resistor (about 50 Ω) at the output for preventing oscillation.

CHARACTERISTICS CURVES

Operating Current vs. Operating Voltage

(No Input Signal, $R_L = \infty$, $T_a = 25^\circ\text{C}$)

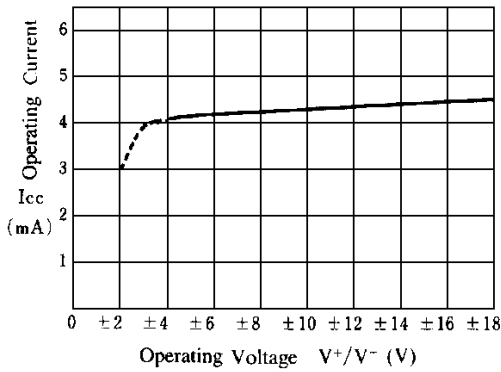

Equivalent Input Noise Voltage vs. Source Resistance

($V^+/V^- = \pm 15\text{V}$, $T_a = 25^\circ\text{C}$)

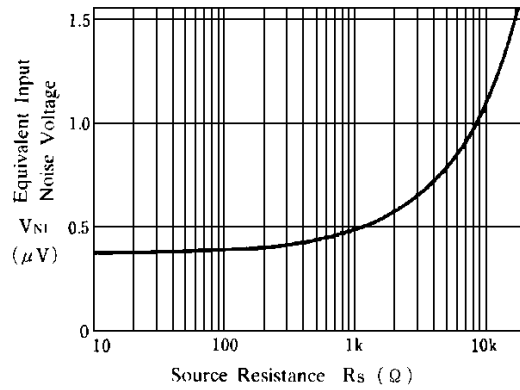

Maximum Output Voltage Swing vs. Frequency

($V^+/V^- = \pm 15\text{V}$, $R_L = 2\text{k}\Omega$, $T_a = 25^\circ\text{C}$)

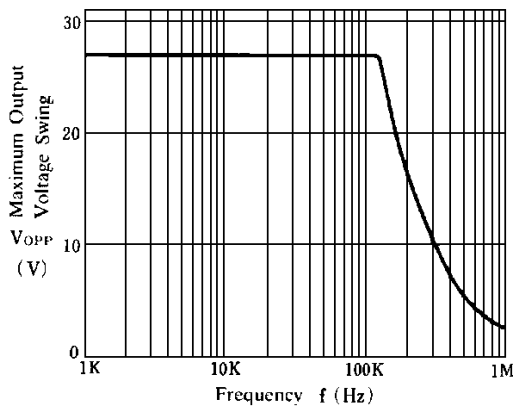

Operating Current vs. Temperature

($V^+/V^- = \pm 15\text{V}$)

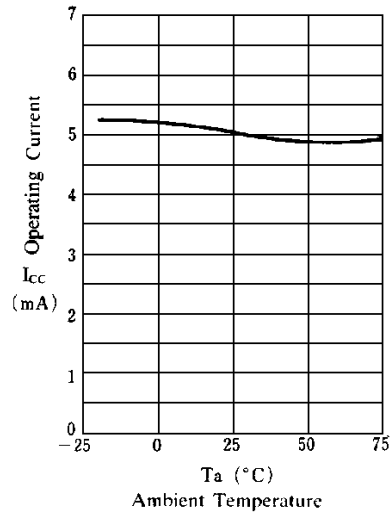

Maximum Output Voltage Swing

($V^+/V^- = \pm 15\text{V}$, $T_a = 25^\circ\text{C}$)

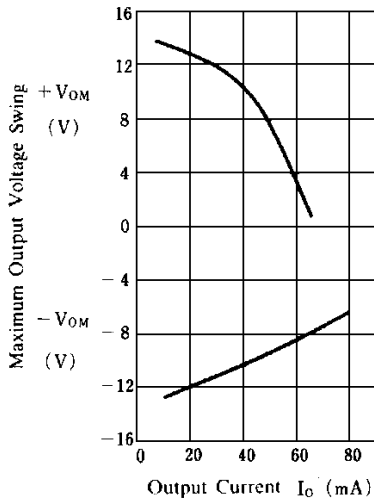

Voltage Gain, Phase vs. Frequency

($V^+/V^- = \pm 15\text{V}$, $R_L = 2\text{k}\Omega$, $C_L = 100\text{pF}$, 40dB Amp, $T_a = 25^\circ\text{C}$)

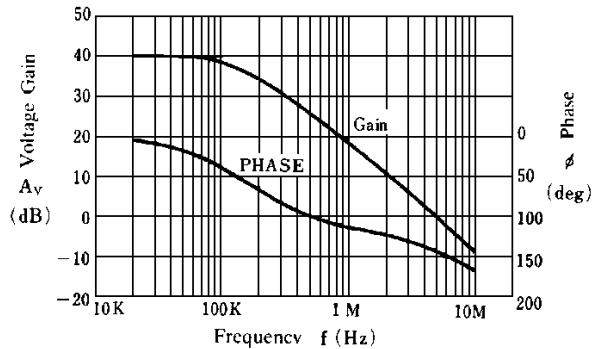

Maximum Output Voltage Swing vs. Operating Voltage
($T_a = 25^\circ\text{C}$)

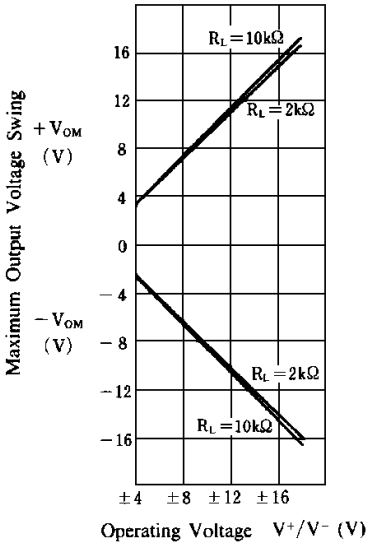

Maximum Output Voltage Swing vs. Load Resistance
($V^+/V^- = \pm 15\text{V}$, $T_a = 25^\circ\text{C}$)

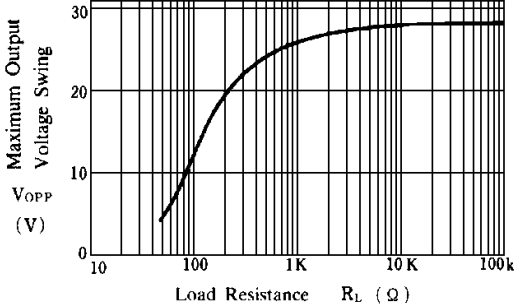

Operating Current vs. Temperature
($V^+/V^- = \pm 15\text{V}$)

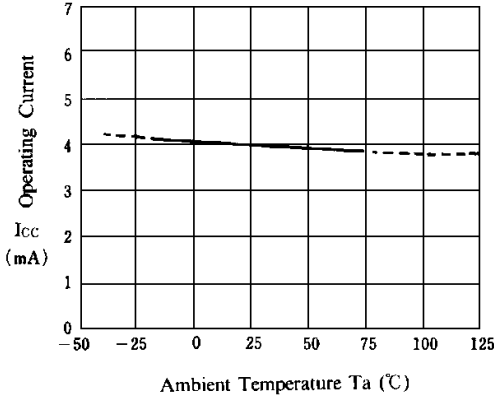

Input Offset Voltage vs. Temperature
($V^+/V^- = \pm 15\text{V}$)

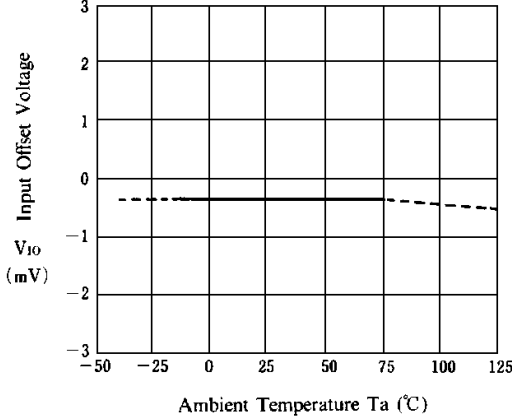

Input Bias Current vs. Temperature
($V^+/V^- = \pm 15\text{V}$)

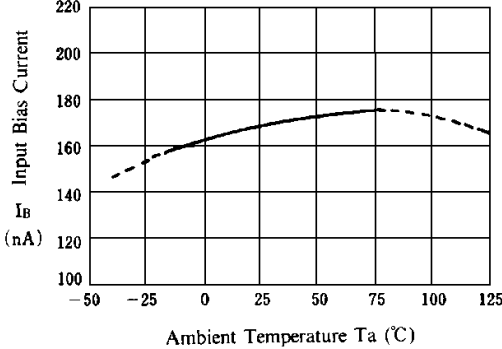

Maximum Output Voltage vs. Temperature
($V^+/V^- = \pm 15\text{V}$, $R_L = 2\text{k}\Omega$)

